

EXPLORE NEW CHALLENGES & EXCITING LEARNING TIPS

NEUE HERAUSFORDERUNGEN UND PRAKTISCHE TIPPS! / RELÈVE DE NOUVEAUX DÉFIS ET FAIS LE PLEIN D'APPRENTISSAGES !
 CONSEJOS PARA UNA DIVERTIDA CONSTRUCCIÓN! / ONTDEK NIEUWE BOUWMOGELIJKHEDEN EN COOLE WETJES!

DISCOVER NEW PLANS

Anleitungen für tolle Herausforderungen in verschiedenen Schwierigkeitsstufen entdecken!
 Découvrez différentes configurations pour chaque niveau de difficulté !
 Descubre diferentes configuraciones para cada nivel de dificultad.
 Ontdek nieuwe bouwplannen op verschillende moeilijkheidsniveaus!



FIND MORE WAYS TO PLAY AND BUILD

Scannen Sie den QR-Code, um weitere Aufbau- und Spielmöglichkeiten zu sehen.
 Scanne le QR code pour découvrir d'autres idées de parcours et de constructions spectaculaires !
 ¡Escanear el código QR para encontrar más ideas de construcciones divertidas!
 Scan de QR-code en bekijk nog meer mogelijkheden om te bouwen en spelen!

CHOOSE YOUR LANGUAGE









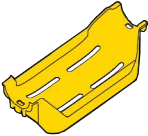
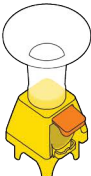

Wählen Sie Ihre Sprache aus!
 Choisissez ta langue !
 Elige un idioma. / Kies je taal

  WWW.VTECHKIDS.COM/MARBLERUSH	  WWW.VTECH-JOUETS.COM/NO5-MARQUES/MARBLERUSH
  WWW.VTECH.ES/NUESTRAS-MARCAS/MARBLERUSH	  WWW.VTECHKIDS.CA/MARBLERUSH
  WWW.VTECH.COM.AU/MARBLERUSH	  WWW.VTECH.DE/MARKEN/MARBLERUSH
  WWW.VTECH.CO.UK/MARBLERUSH	  WWW.VTECHNL.COM/ONZE-MERKEN/MARBLERUSH

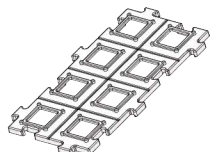

COMPONENTS

BAUTEILE / PIÈCES
PIEZAS / ONDERDELEN

M-01  x 1	M-07  x 1	M-14  x 1	T-01  x 1
T-02  x 1	T-03  x 3	T-05  x 1	T-06  x 2
T-08  x 2	P-01  x 2	B-01  x 8	B-02  x 4
B-04  x 3	Marbles MarBalls/MarbleBilles Marbles/Knikkers  x 3	TM & © 2021 VTECH HOLDINGS LIMITED. ALL RIGHTS RESERVED. PRINTED IN CHINA. TM & © 2021 VTECH HOLDINGS LIMITED. ALLE RECHTE VOORBEHALTEN. GEDRUCKT IN CHINA. TM & © 2021 VTECH HOLDINGS LIMITED. TOUS DROITS RÉSERVÉS. IMPRIMÉ EN CHINE. TM & © 2021 VTECH HOLDINGS LIMITED. TODOS LOS DERECHOS RESERVADOS. IMPRESO EN CHINA. TM & © 2021 VTECH HOLDINGS LIMITED. ALLE RECHTEN VOORBEHOUDEN. PRINTED IN CHINA.	

CONSTRUCTION PLAN

AUFBAUANLEITUNG / IDÉES DE PARCOURS PAR NIVEAU
IDÉAS DE CONSTRUCCIONES POR NIVEL / BOUWPLAN

LEVEL 1

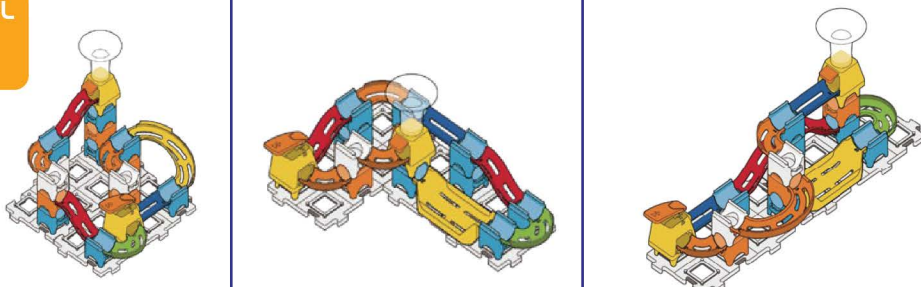

< 01 >

LEVEL 1

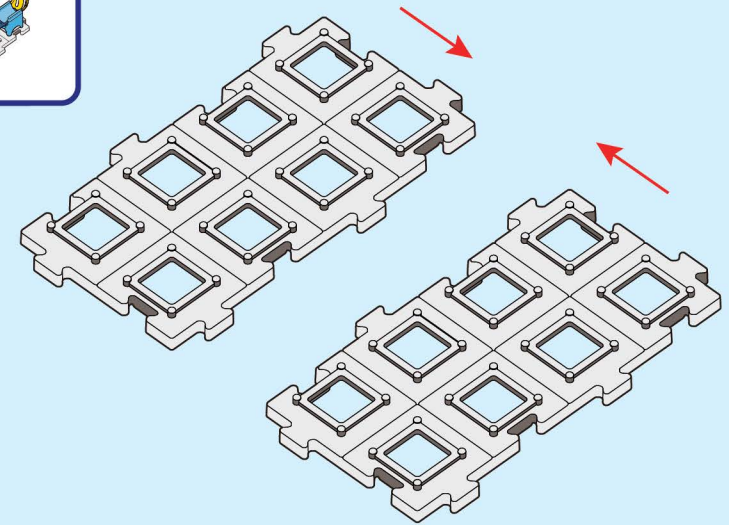
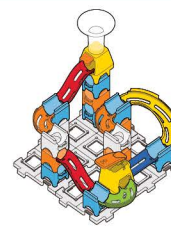

	1	2	3	4
A				
B				
C				
D				

1-1



 x 3

B-01

 x 2

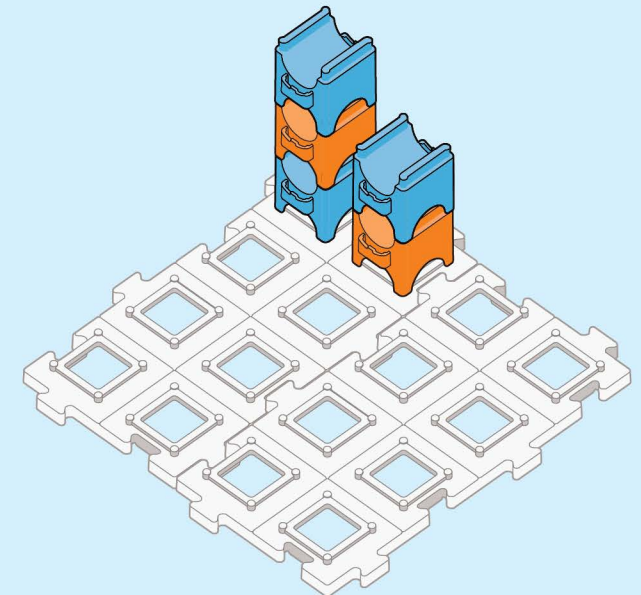



B-02







	1	2	3	4
A				
B				
C				
D				

< 02 >

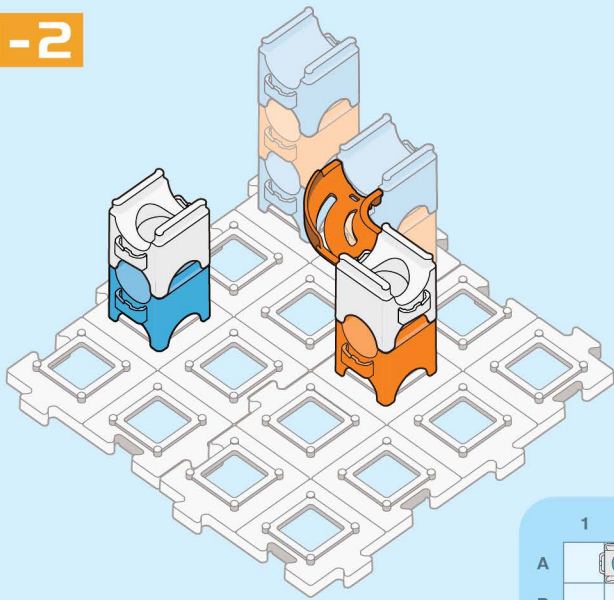
1-2

-  x 1
- B-01**
-  x 1
- B-02**
-  x 2
- B-04**
-  x 1
- T-03**





	1	2	3	4
A				
B				
C				
D				



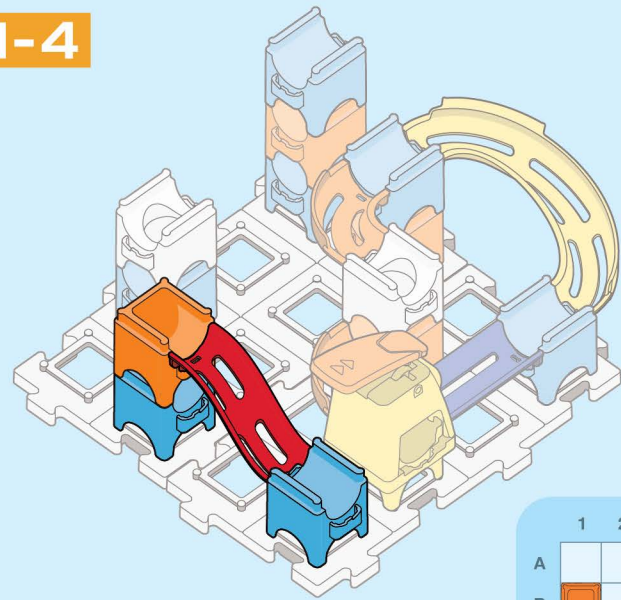

1-4

-  x 2
- B-01**
-  x 1
- B-02**
-  x 1
- T-08**





	1	2	3	4
A				
B				
C				
D				

1-3

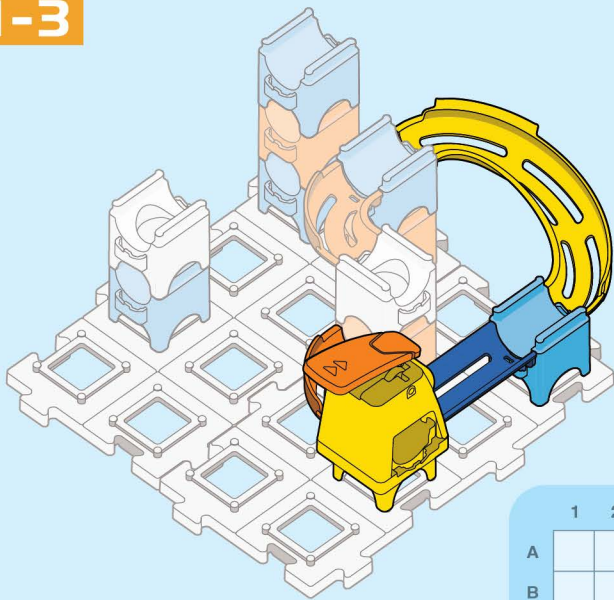
-  x 1
- B-01**
-  x 1
- M-01**
-  x 1
- T-06**
-  x 1
- T-03**
-  x 1
- T-01**





	1	2	3	4
A				
B				
C				
D				

1-5

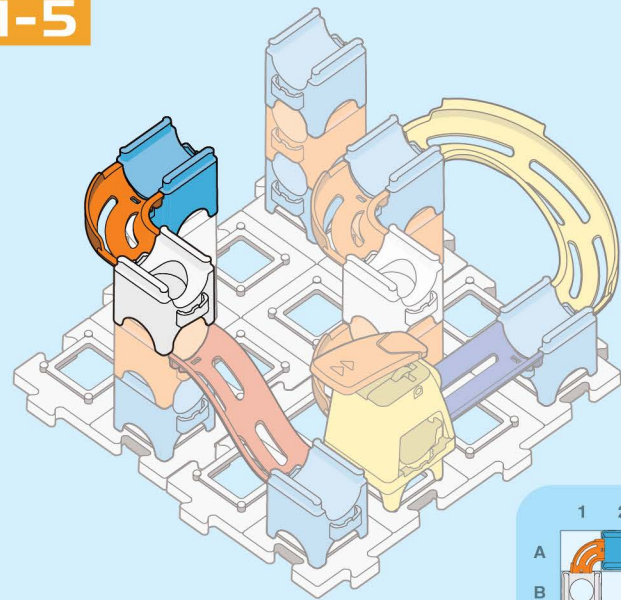
-  x 1
- B-01**
-  x 1
- B-04**
-  x 1
- T-03**



	1	2	3	4
A				
B				
C				
D				

1-6

 x 1
T-05

 x 1
M-14

 x 1
T-08

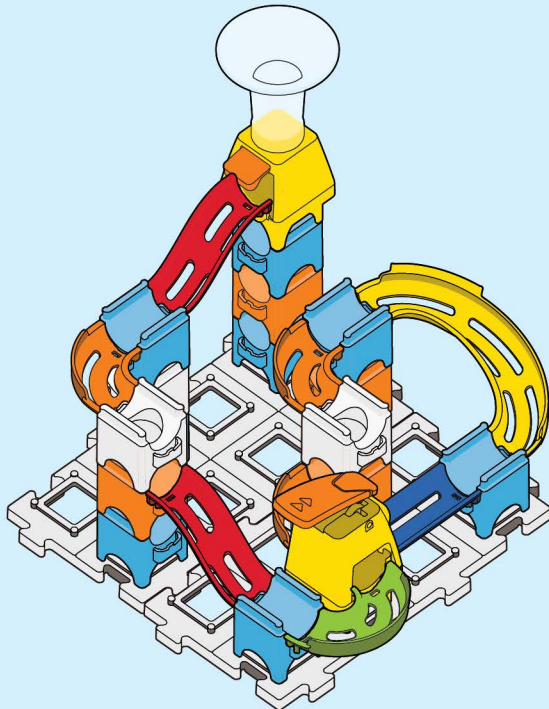
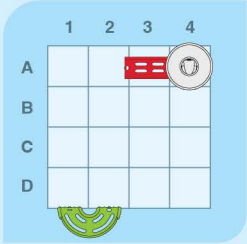
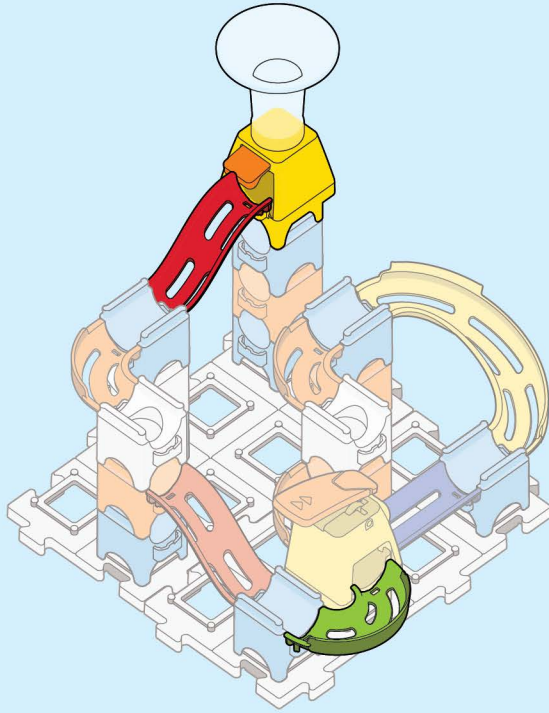

<05>

LEVEL
1

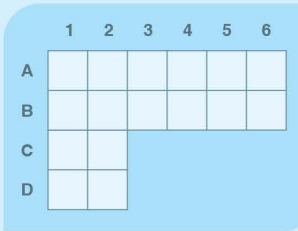
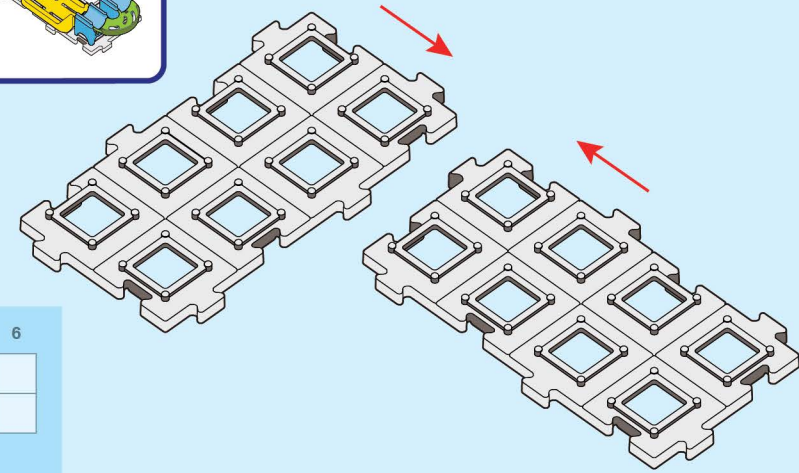
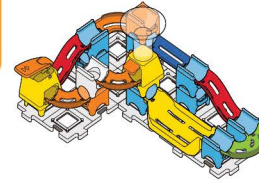

 x 2
B-01

 x 1
M-01

 x 1
T-08

1-1

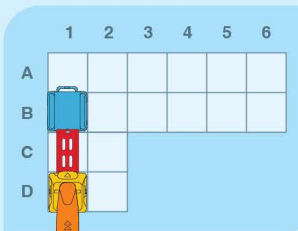
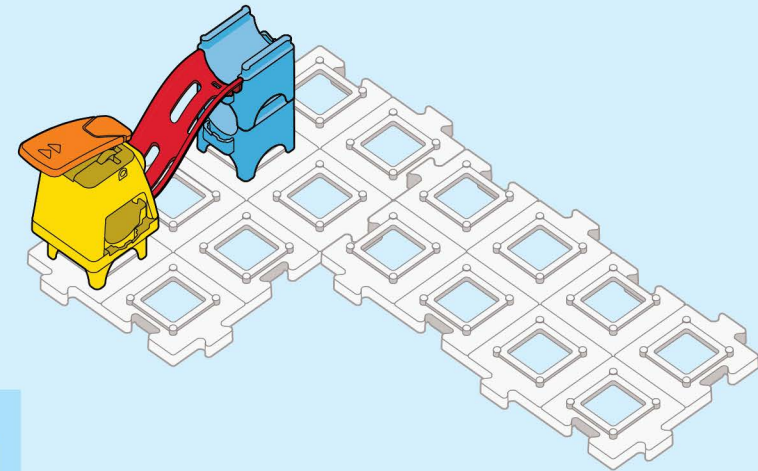



<06>

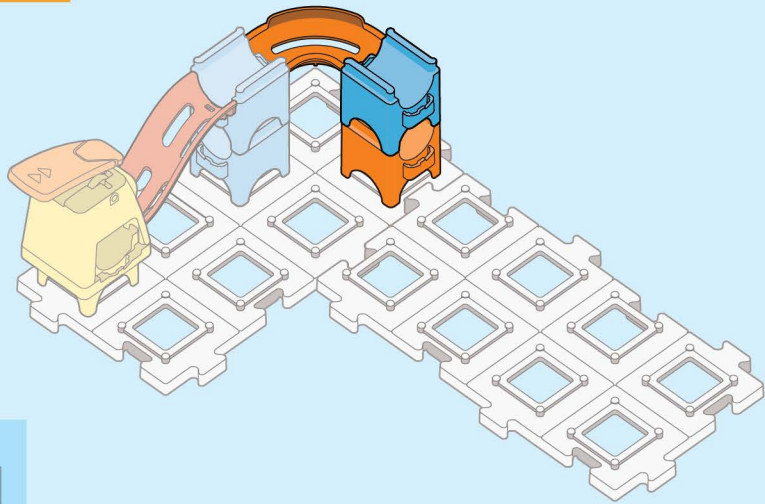

1-2

-  **x 1**
B-01
-  **x 1**
B-02
-  **x 1**
T-03





	1	2	3	4	5	6
A						
B						
C						
D						

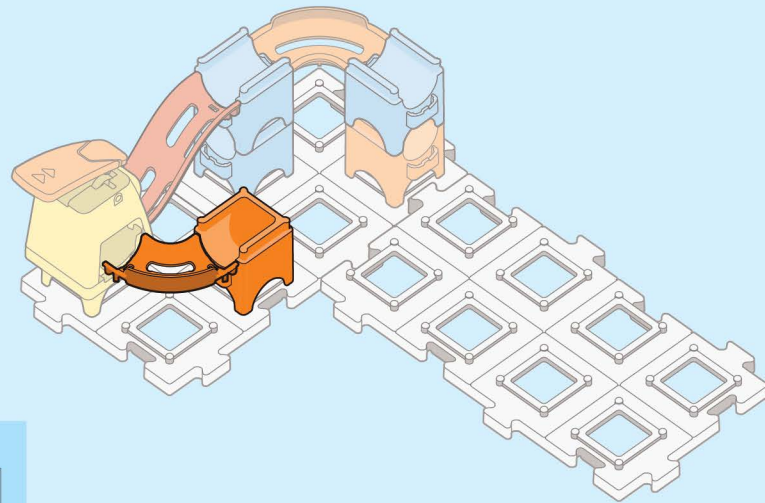

1-3

-  **x 1**
B-02
-  **x 1**
T-03





	1	2	3	4	5	6
A						
B						
C						
D						

1-4

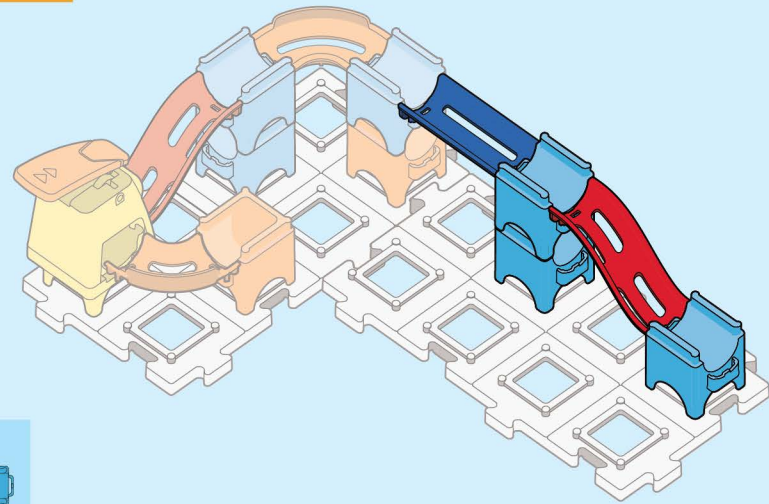
-  **x 3**
B-01
-  **x 1**
T-08
-  **x 1**
T-06







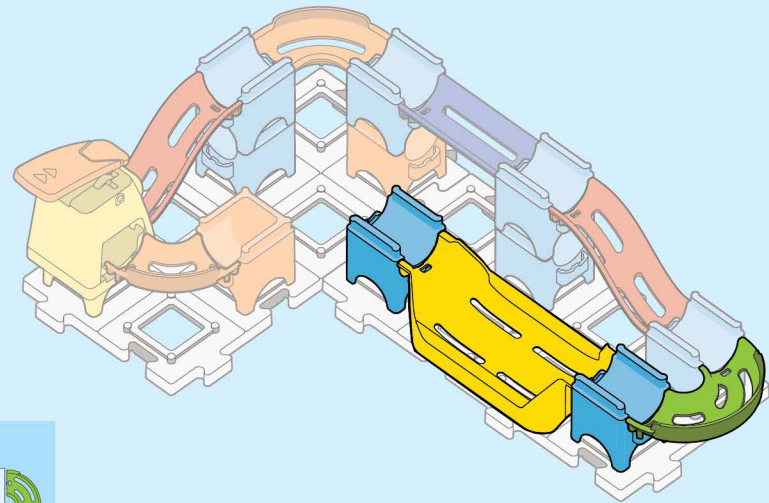

	1	2	3	4	5	6
A						
B						
C						
D						

1-5

-  **x 2**
B-01
-  **x 1**
M-07
-  **x 1**
T-05



	1	2	3	4	5	6
A						
B						
C						
D						

-  x 1
- B-04**
-  x 1
- M-14**
-  x 1
- T-03**

1-6

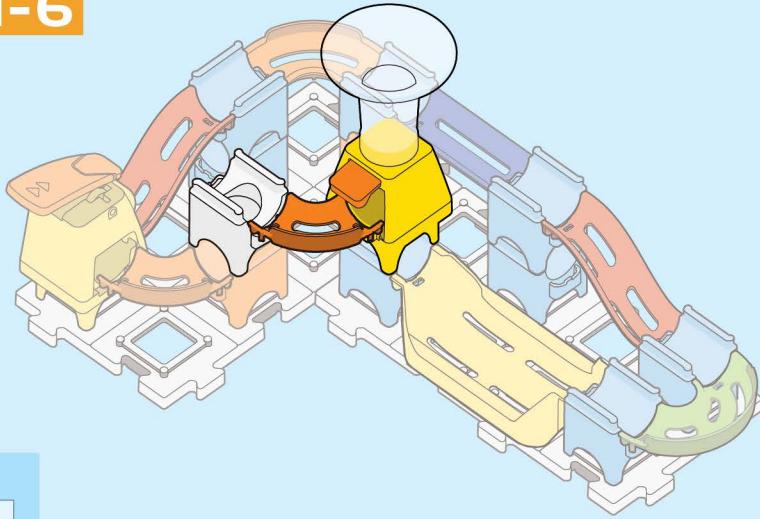

	1	2	3	4	5	6
A						
B						
C						
D						

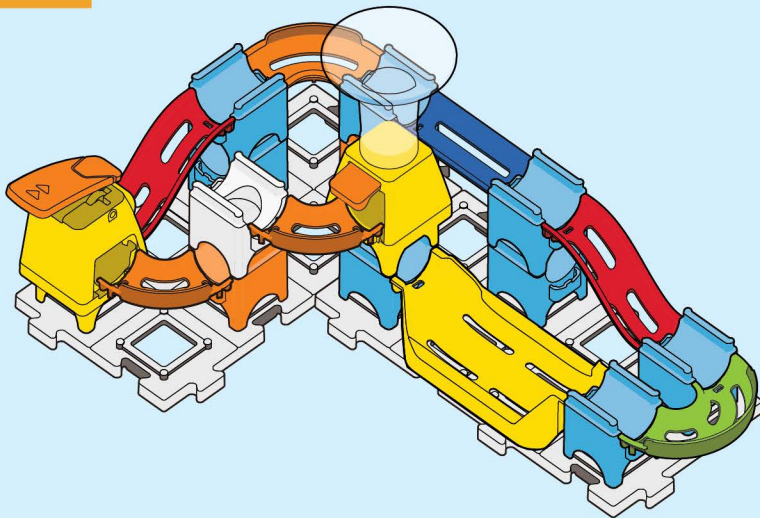

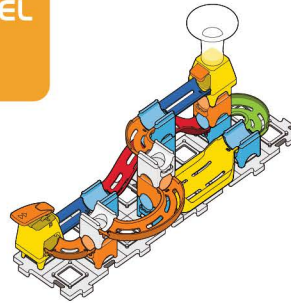

LEVEL
1

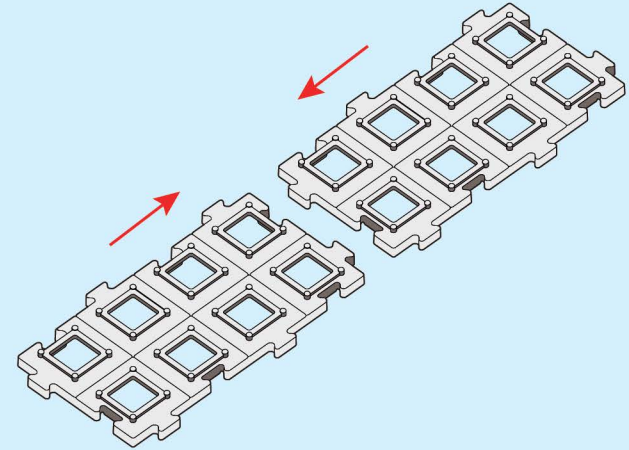

	1	2	3	4	5	6	7	8
A								
B								



-  x 1
- B-01**
-  x 1
- M-01**
-  x 1
- T-06**

1-1

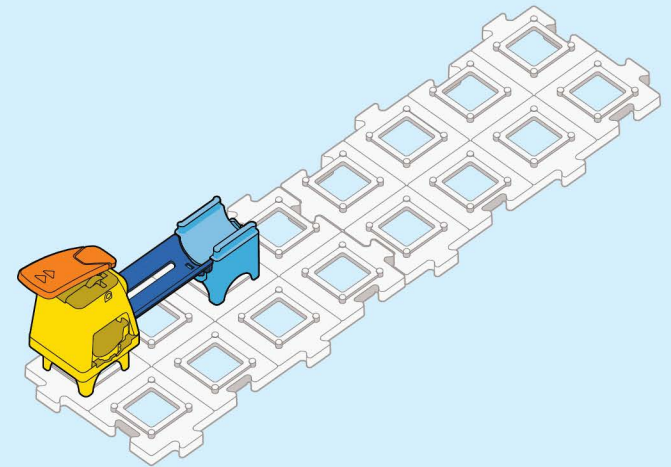

	1	2	3	4	5	6	7	8
A								
B								



x 2

B-01



x 1

T-08

1-2

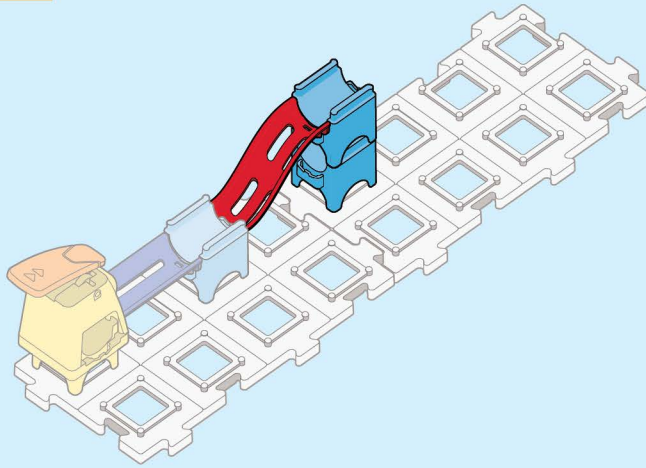

1 2 3 4 5 6 7 8

A									
B									



x 1

B-01



x 1

M-07



x 1

B-02



x 1

T-03

1-4

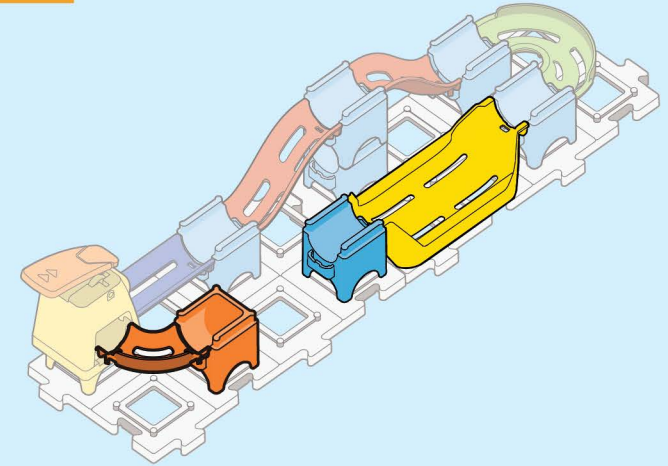

1 2 3 4 5 6 7 8

A									
B									



x 2

B-01



x 1

T-08



x 1

T-05

1-3

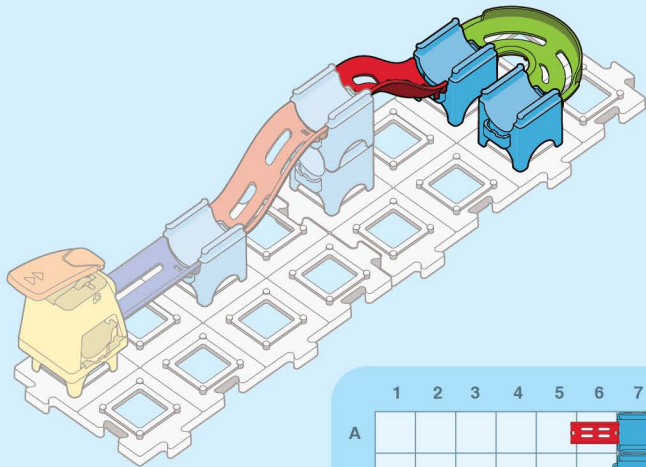

1 2 3 4 5 6 7 8

A									
B									



x 1

B-01



x 1

B-02



x 1

T-06



x 1

M-14

1-5

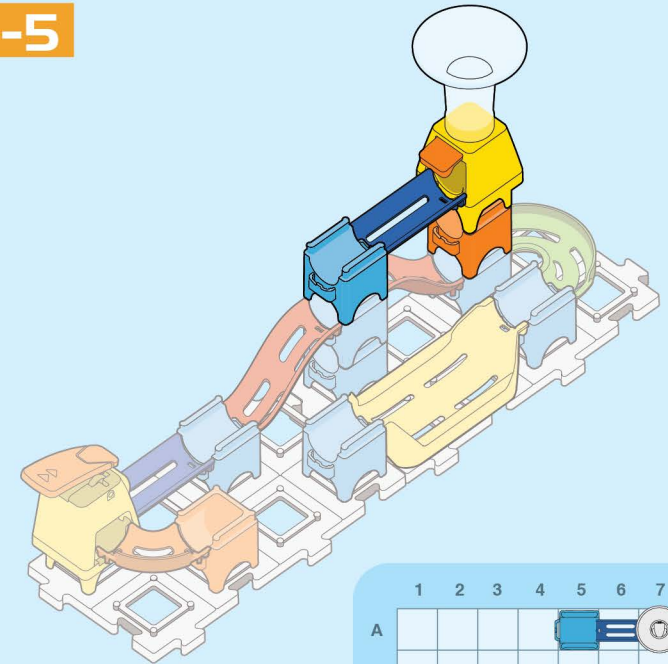

1 2 3 4 5 6 7 8

A									
B									



x 1

B-02



x 2

B-04



x 1

T-03



x 1

T-02

1-6

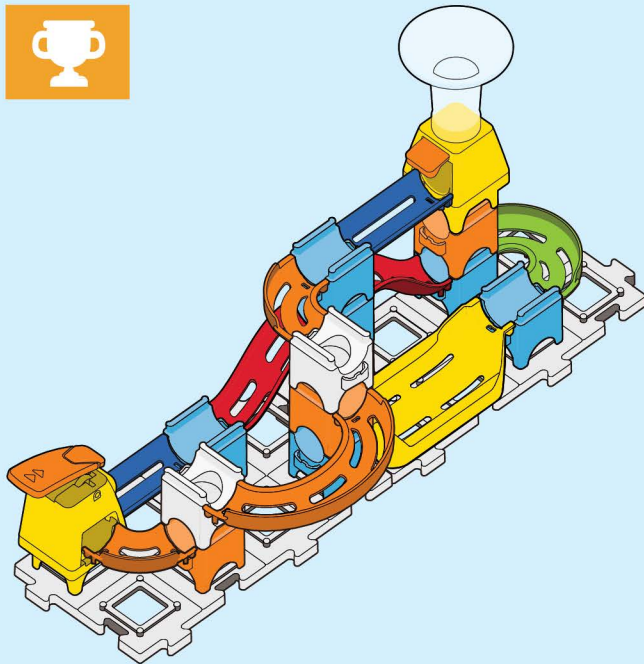
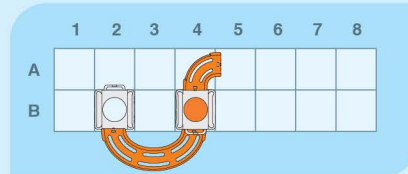
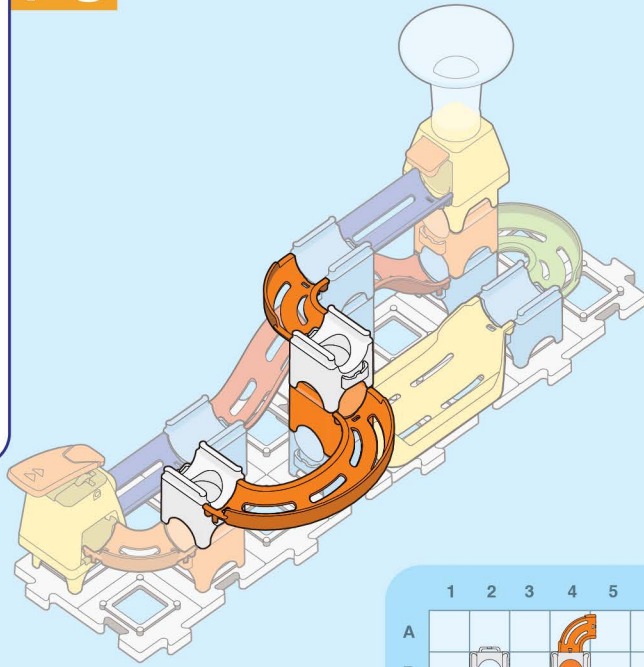

CREATE AN EXTREME PLAYSET

KOMBINIEREN SIE SPIELSETS FÜR NOCH MEHR SPIELSPASS! / CRÉE UN CIRCUIT GÉANT SENSATIONNEL !
ICREA UN ESPECTACULAR CIRCUITO GIGANTE! / COMBINEER DE SPEELSETS. DE MOGELIJKHEDEN ZIJN EINDELOOS!



FIND THIS CONSTRUCTION PLAN ONLINE BY SCANNING THE QR CODE ON THE BACK
SCANNEN SIE DEN QR-CODE AUF DER RÜCKSEITE. UM SICH WEITERE AUFBAUANLEITUNGEN ONLINE ANZUSEHEN.
RETROUVE LES ÉTAPES DE CONSTRUCTION DE CE PARCOURS INCROYABLE EN LIGNE EN SCANNANT LE QR CODE AU
DOS DE CE MANUEL.
ENCUENTRA LOS PASOS PARA CONSTRUIR ESCANEANDO EL CÓDIGO QR EN LA PARTE POSTERIOR DE ESTE MANUAL.
SCAN DE QR-CODE OP DE ACHTERZIJDE VAN DEZE HANDLEIDING EN BEKIJK DIT BOUWPLAN ONLINE.